

Article number: 439500240
 Description: Rota-fix shaft-hub connection F240x305
 Steel
 Note: Self centering. Very high torque

Measures

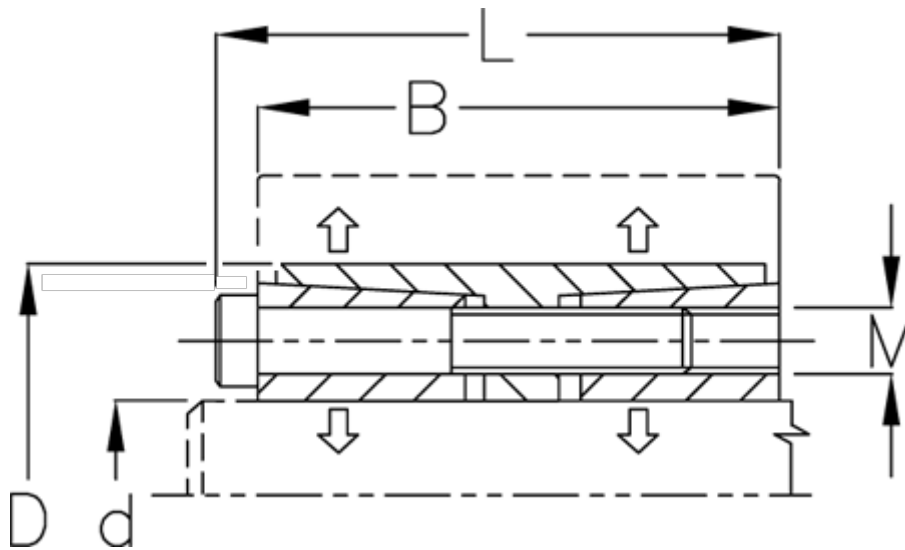

B mm	= 146
d H8 mm	= 240
D mm	= 305
Fit tolerance	= Aksel h8, Nav H8
F kN torque	= 1710.0
L mm	= 162
M mm	= M16
P N/mm ² surface pressure on shaft/hub	= 109

Surface roughness	= R? ? 3.2 µm
T N m torque	= 205000
Ts N m bolt tightening torque	= 355.0